

FOSET.

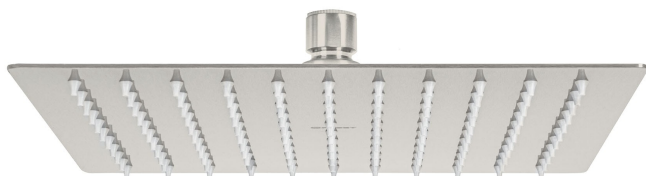

CÓDIGO: 45782 CLAVE: R-310SN

Regadera satín 10" plato cuadrado delgado sin brazo, Foset

- Cabeza de acero inoxidable
- Para mayor flujo de agua se puede retirar el reductor
- Compatible con el brazo y chapetón BCH-750N marca Foset ®

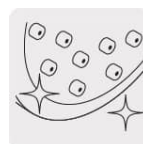
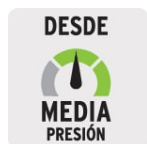
Boquillas fácil
limpieza

Articulada

Certificaciones y garantías

- Cumple la norma NOM-008-CONAGUA



Especificaciones

Acabado	Satín
Diámetro de la cabeza	10" (25 cm)
Presión de trabajo	1 kgf/cm ² a 6 kgf/cm ²
Consumo mínimo máximo	4 l/min 10 l/min
Conexión de entrada	1/2" - 14 NPT
Empaque individual	Caja
Inner	1
Master	4
Pallet	144

País de origen

Fabricado en China bajo las estrictas especificaciones de Truper

Imágenes complementarias

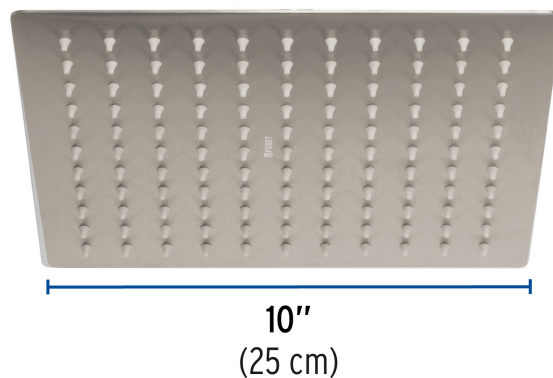
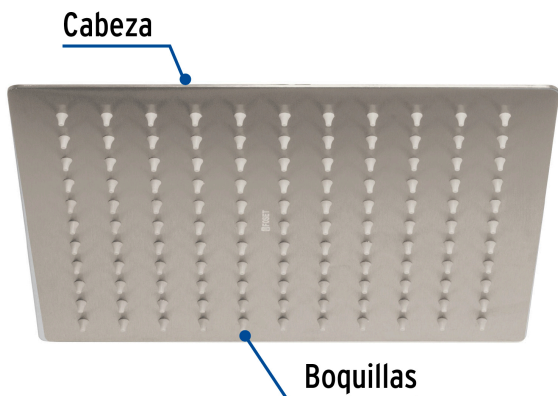

Para mayor flujo de agua se puede retirar el reductor

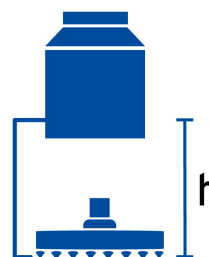
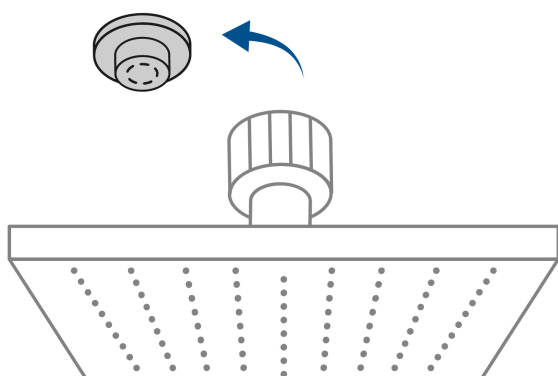

Altura (h)	Presión		
	kPa	kgf / cm ²	PSI
2 m	20	0.2	2.8
3 m	30	0.3	4.2
4 m	40	0.4	5.6

Imágenes complementarias

Compatible con el brazo y chapetón para
regadera, 50 cm, satinado



BCH-750N

